

03250197

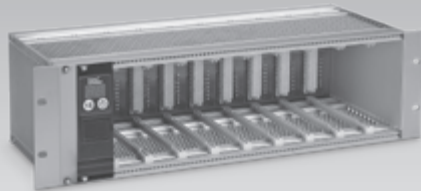

Operating instructions
Fieldbus interface PFA
Module subrack BGT



Contents

Fieldbus interface PFA
Module subrack BGT..... 1
Contents 1
Safety 1
Checking the usage..... 2
Installing the BGT..... 3
Wiring the BGT 3
Setting the PFA..... 3
Installing the PFA..... 4
Replacing the PFA..... 4
Labelling the PFA..... 5
Commissioning..... 5
Manual operation..... 5
Faults..... 6
Technical data 7
Logistics 7
Disposal 7
BGT SA-9U/1DP connection diagram 8
BGT SA-8U/1DP connection diagram 10
Accessories 12
Certification 12
Contact 12

Safety

Please read and keep in a safe place



Please read through these instructions carefully before installing or operating. Following the installation, pass the instructions on to the operator. This unit must be installed and commissioned in accordance with the regulations and standards in force. These instructions can also be found at www.docuthek.com.

Explanation of symbols

- **1, 2, 3**... = Action
- > = Instruction

Liability

We will not be held liable for damage resulting from non-observance of the instructions and non-compliant use.

Safety instructions

Information that is relevant for safety is indicated in the instructions as follows:

⚠ DANGER
Indicates potentially fatal situations.

⚠ WARNING
Indicates possible danger to life and limb.

! CAUTION
Indicates possible material damage.

All interventions may only be carried out by qualified gas technicians. Electrical interventions may only be carried out by qualified electricians.

Conversion, spare parts

All technical changes are prohibited. Only use OEM spare parts.

Checking the usage

PFA 700

Fieldbus interface for interworking of up to nine automatic burner control units PFU 760 or PFU 780 to industrial communication networks using PROFIBUS DP. The PFA 700 can be plugged into the pre-wired module subrack BGT SA-9U/1DP, together with the automatic burner control units.

PFA 710

Fieldbus interface for interworking of up to eight automatic burner control units PFU 780 to industrial communication networks using PROFIBUS DP. The PFA 710 can be plugged into the pre-wired module subrack BGT SA-8U/1DP, together with the automatic burner control units.

PFA 700, PFA 710

This function is only guaranteed when used within the specified limits – see page 7 (Technical data). Any other use is considered as non-compliant.

Type code

Code	Description
PFA	Fieldbus interface For connecting:
700	PFU 760
710	PFU 780
T	Mains voltage: 220/240 V AC
N	110/120 V AC
Z	Special version

Part designations

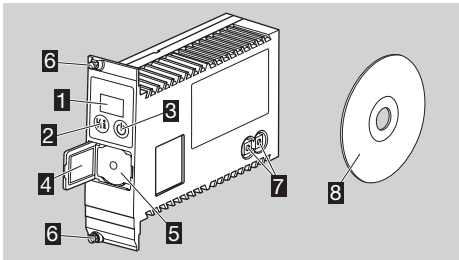

- 1 LED display for program status and error messages
- 2 Reset/Information button
- 3 On/Off button
- 4 Type label
- 5 Connection for opto-adaptor
- 6 Screws for attachment to the subrack
- 7 Code switches for address setting
- 8 CD with device master data (GSD file)

Input voltage and ambient temperature – see type label.

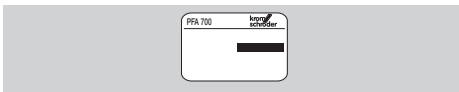

BGT SA-9U/1DP

Pre-wired module subrack for a fieldbus interface PFA 700 with nine further slots for automatic burner control units PFU 760 or PFU 780.

BGT SA-8U/1DP

Pre-wired module subrack for a fieldbus interface PFA 710 with eight further slots for automatic burner control units PFU 780.

BGT SA-9U/1DP, BGT SA-8U/1DP

This function is only guaranteed when used within the specified limits – see page 7 (Technical data). Any other use is considered as non-compliant.

Type code

Code	Description
BGT	19" module subrack
SA	For PFA and PFU
-9U	Slots: 9 x for PFU
-8U	8 x for PFU
/1DP	1 PFA with PROFIBUS DP

Part designations

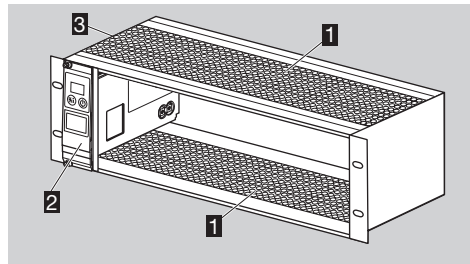

- 1 Perforated plate
- 2 Fieldbus interface PFA 700/PFA 710
- 3 Type label

Input and output voltage, enclosure and ambient temperature – see type label.

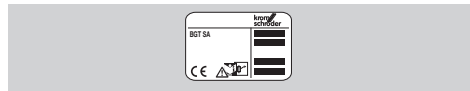

Installing the BGT

! CAUTION

Please observe the following to ensure that the PFA and the automatic burner control units PFU are not damaged during operation:

- It must be ensured that the module subrack is well ventilated in order to avoid overheating.
- In the case of several module subracks mounted on top of one another, we recommend removing the perforated plates **A** from between the module subracks, and inserting a rack-mounted fan **B** underneath the module subracks.

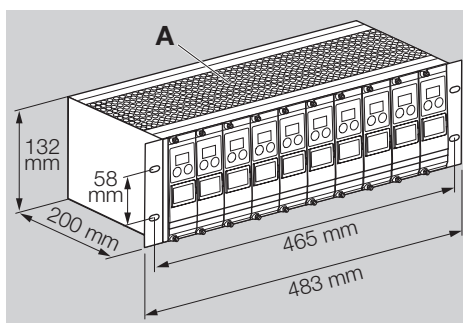
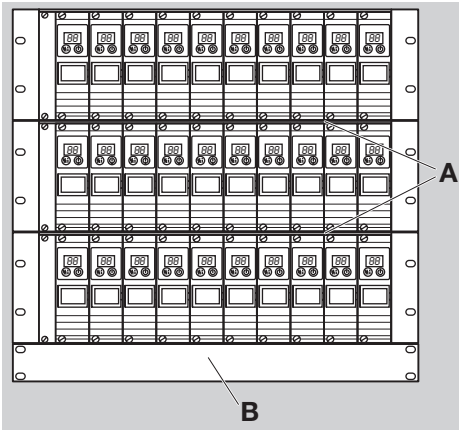

⚠ DANGER

Electric shocks can be fatal! Module subracks must be integrated in the equipotential bonding system.

- ▷ Installation position: any.
- ▷ Distance between PFU and burner: max. 100 m (328 ft).

Wiring the BGT

- 1 Disconnect the system from the electrical power supply.
 - ▷ Use a resistor with low impedance at high frequencies for grounding the BGT.
 - ▷ Ensure an equipotential bond between the various slaves.
 - ▷ Switch on the terminal resistor on the first (PLC) and last (BGT/PFA) station on the Profibus plug – see page 12 (Profibus plug for PFA).
 - ▷ There are four digital inputs (X10.1 to X10.4) and four digital outputs (X10.6 to X10.9) available.
 - ▷ Load per input: 24 V DC, $\pm 10\%$, < 10 mA.
 - ▷ Load per output: relay contact, max. 1 A, 24 V (not fused internally).

BGT SA-9U/1DP

- 2 Wire as shown on the circuit diagram, see page 8 (BGT SA-9U/1DP connection diagram).

BGT SA-8U/1DP

- 2 Wire as shown on the circuit diagram, see page 10 (BGT SA-8U/1DP connection diagram).

Setting the PFA

- ▷ All the unit-specific parameters for the PFA are saved in a device master data file (GSD file, see www.docutheck.com).
- 1 Copy device master data for the PFA into the programmable logic controller (PLC).
 - ▷ The steps required to copy the file are described in the instructions for the PLC.
 - 2 Configure the PROFIBUS DP using the appropriate tools for the PLC you are using.
 - ▷ The PFA will automatically identify the baud rate (max. 1.5 Mbit/s).
 - ▷ The max. range depends on the baud rate:

Baud rate [kBit/s]	Range	
	[m]	[yd]
93.75	1200	1300
187.5	1000	1090
500	400	545
1500	200	220

- ▷ The ranges may be increased by using repeaters. Do not connect more than three repeaters in series.

PFA 700

- ▷ Input/output bytes: inputs 5 bytes, outputs 3 bytes.

Input bytes (PFA ▶ master)

Bit	Byte 0	Byte 1	Byte 2	Byte 3	Byte 4
0	⌊ PFU 1	⌊ PFU 9	⌊ PFU 8	⌊ PFU 7	⌊ PFA
1	⌊ PFU 2	⌊ PFU 1	⌊ PFU 9	⌊ PFU 8	
2	⌊ PFU 3	⌊ PFU 2	⌊ PFU 1	⌊ PFU 9	
3	⌊ PFU 4	⌊ PFU 3	⌊ PFU 2	⌊ PFU 1	⬅ 1
4	⌊ PFU 5	⌊ PFU 4	⌊ PFU 3	⌊ PFU 2	⬅ 2
5	⌊ PFU 6	⌊ PFU 5	⌊ PFU 4	⌊ PFU 3	⬅ 3
6	⌊ PFU 7	⌊ PFU 6	⌊ PFU 5	⌊ PFU 4	⬅ 4
7	⌊ PFU 8	⌊ PFU 7	⌊ PFU 6	⌊ PFA	

Output bytes (master ► PFA)

Bit	Byte 0	Byte 1	Byte 2
0	PFU 1	PFU 9	PFU 8
1	PFU 2	PFU 1	PFU 9
2	PFU 3	PFU 2	PFA
3	PFU 4	PFU 3	
4	PFU 5	PFU 4	► 1
5	PFU 6	PFU 5	► 2
6	PFU 7	PFU 6	► 3
7	PFU 8	PFU 7	► 4

PFA 710

► Input/output bytes: inputs 5 bytes, outputs 5 bytes.

Input bytes (PFA ► master)

Bit	Byte 0	Byte 2	Byte 3	Byte 4
0	PFU 1	PFU 5	PFU 7	PFA
1	PFU 1	PFU 3	PFU 5	PFU 7
2	PFU 1	PFU 3	PFU 5	PFU 7
3	PFU 1	PFU 3	PFU 5	PFU 7
4	PFU 2	PFU 4	PFU 6	PFU 8
5	PFU 2	PFU 4	PFU 6	PFU 8
6	PFU 2	PFU 4	PFU 6	PFU 8
7	PFU 2	PFU 4	PFU 6	PFU 8

Output bytes (master ► PFA)

Bit	Byte 0	Byte 1	Byte 2	Byte 3	Byte 4
0	PFU 1	PFU 3	PFU 5	PFU 7	PFA
1	PFU 1	PFU 3	PFU 5	PFU 7	► 1
2	PFU 1	PFU 3	PFU 5	PFU 7	► 2
3	PFU 1	PFU 3	PFU 5	PFU 7	► 3
4	PFU 2	PFU 4	PFU 6	PFU 8	► 4
5	PFU 2	PFU 4	PFU 6	PFU 8	PFU 8
6	PFU 2	PFU 4	PFU 6	PFU 8	PFU 8
7	PFU 2	PFU 4	PFU 6	PFU 8	PFU 8

Legend

↓	Ready for operation
⏏	Burner start-up signal
⏏	Start-up signal, pilot burner
⏏	Start-up signal, main burner
⏏	Purge
⏏	External air valve control
⏏	Burner operating signal
⏏	Operating signal, pilot burner
⏏	Operating signal, main burner
⏏	Fault signal
⏏	Manual mode
↺	Reset
←	Input signal
→	Output signal

Address setting

3 Set the Profibus address on the PFA using the code switches.

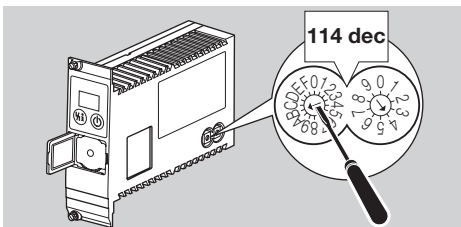

► At the factory, the Profibus address on the PFA is set to 04.

Installing the PFA

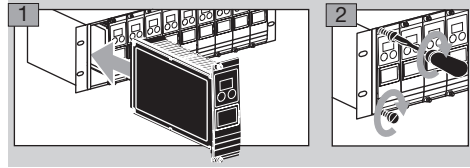

► Ensure that the PFA is correctly inserted.

Replacing the PFA

► The old PFA 700 (Order No. 84395100 – see type label) can be replaced with the new PFA 700 (Order No. 84395101 or 84395102) in the module subrack BGT SA-9U/1DP (Order No. 84402283).

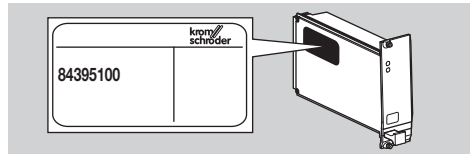

► To increase the EMC interference immunity, the new Profibus plug supplied must be used for the new PFAs (Order No. 84395101 or 84395102).

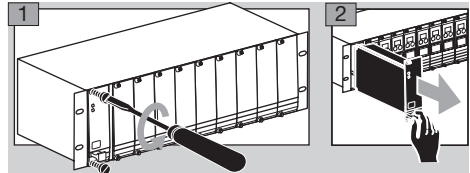

3 Check the voltage.

4 Read off the Profibus address on the old PFA.

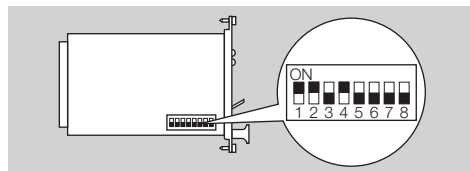

5 Accept and set the Profibus address on the new PFA – see page 4 (Address setting).

6 Install the new PFA – see page 4 (Installing the PFA).

7 Check the operating parameters for manual mode on the new PFA and adjust where applicable.

8 Replace the Profibus plug on the BGT with the Profibus plug with shielding capacitor – see page 12 (Profibus plug for PFA).

Labelling the PFA



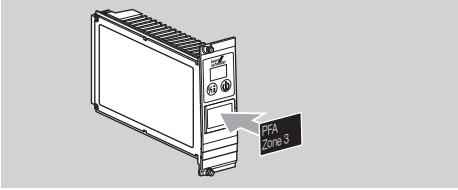

- ▷ Each PFA can be labelled individually.
- 1** Attach label or sticker to the space provided on the handle of the fieldbus interface.



- ▷ The size of this space is 28 × 18 mm (1.10 × 0.71").



Commissioning

- ▷ During operation, the 7-segment display shows the program status:

	Unit Off
	Programming mode
	(blinking dots) Manual mode
	Normal operation
	Profibus fault

⚠ WARNING

Check the system for tightness before commissioning. Do not start the PFA until the downstream automatic burner control units have been properly commissioned.

- 1** Switch on the system.
 - ▷ The display indicates .
- 2** Switch on the PFA by pressing the On/Off button.
 - ▷ As soon as the flashing display  goes out and the display indicates , the data traffic is operating.

Manual operation

The PFA can be started in manual mode for burner adjustment or for fault-finding:

- ▷ Using the opto-adaptor and the BCSofT software, the operating mode parameters for manual mode can be changed.

! CAUTION

If parameters are changed, stick the supplied adhesive label "Changed parameters" on the PFA – see page 12 (Accessories).

- 1** Switch on the system.
- 2** Apply voltage to terminals 19 and 20 on the terminal strip X10.
- 3** Switch on the PFA by pressing the On/Off button while holding down the Reset/Information button. Hold the button until both dots in the display start to blink.
 - ▷ The display indicates .
 - ▷ Deactivate manual mode by pressing the On/Off button.
 - ▷ After 5 minutes in manual mode, the PFA switches back to normal operation automatically.

When using operating mode parameters set at the factory

PFA 700, PFA 710





Parameter 43 = 1

- 4** Press the Reset/Information button for 1 s.
 - ▷ The display indicates step .
 - ▷ The PFUs start the burners and open the air valve via the external control system (programming of the operating mode at the factory).

When using adjusted operating mode parameters ON/OFF operating mode

PFA 700 in conjunction with PFU 760

Parameter 43 = 2

- 4** Press the Reset/Information button for 1 s.
 - ▷ The display indicates step .
 - ▷ The PFUs start the burners.
- 5** Press the Reset/Information button for 1 s.
 - ▷ The display indicates step .
 - ▷ The PFUs switch off all the burners.
 - ▷ By pressing the Reset/Information button repeatedly, the PFUs are activated to switch between burner start (the display indicates step ) or burner off (the display indicates step .





PFA 700 in conjunction with PFU 760..L

Parameter 43 = 3

- 4** Press the Reset/Information button for 1 s.
 - ▷ The display indicates step .
 - ▷ The PFUs start the burner pre-purge procedure.

⚠ WARNING

The pre-purge duration is not included in the program. Pre-purge until the combustion chamber has been adequately ventilated.

- 5** Press the Reset/Information button for 1 s.
 - ▷ The display indicates step .
 - ▷ The PFUs start the burners.
- 6** Press the Reset/Information button for 1 s.
 - ▷ The display indicates step .
 - ▷ The PFUs switch off all the burners.
 - ▷ By pressing the Reset/Information button repeatedly, the PFUs are activated to switch between pre-purge (the display indicates step ) burner start (the display indicates step ) or burner off (the display indicates step .

PFA 710 in conjunction with PFU 780..L

Parameter 43 = 3

- 4 Press the Reset/Information button for 1 s.
 - ▷ The display indicates step [01].
 - ▷ The PFUs start the burner pre-purge procedure.

WARNING

The pre-purge duration is not included in the program. Pre-purge until the combustion chamber has been adequately ventilated.

- 5 Press the Reset/Information button for 1 s.
 - ▷ The display indicates step [02].
 - ▷ The PFUs start the pilot burners.
- 6 Press the Reset/Information button for 1 s.
 - ▷ The display indicates step [03].
 - ▷ The PFUs start the main burners, the pilot burners remain switched on.
- 7 Press the Reset/Information button for 1 s.
 - ▷ The display indicates step [00].
 - ▷ The PFUs switch off all the burners.
 - ▷ By pressing the Reset/Information button repeatedly, the PFUs are activated to switch between pre-purge (the display indicates step [01]), pilot burner start (the display indicates step [02]), main burner start (the display indicates step [03]) or burner off (the display indicates step [00]).

High/Low operating mode

PFA 700 in conjunction with PFU 760..L

Parameter 43 = 4

- 4 Press the Reset/Information button for 1 s.
 - ▷ The display indicates step [01].
 - ▷ The PFUs start the burner pre-purge procedure.

WARNING

The pre-purge duration is not included in the program. Pre-purge until the combustion chamber has been adequately ventilated.

- 5 Press the Reset/Information button for 1 s.
 - ▷ The display indicates step [03].
 - ▷ The PFUs start the burners.
- 6 Press the Reset/Information button for 1 s.
 - ▷ The display indicates step [04].
 - ▷ The PFUs 760..L activate the external air valves, the burners switch to high-fire rate.
- 7 Press the Reset/Information button for 1 s.
 - ▷ The display indicates step [03].
 - ▷ The PFUs 760..L deactivate the external air valves, the burners switch to low-fire rate.
 - ▷ Each time the Reset/Information button is pressed, the air valves are opened (the burners switch to high-fire rate, the display indicates [04]) or closed (the burners switch to low-fire rate, the display indicates [03]).

PFA 710 in conjunction with PFU 780..L

Parameter 43 = 4

- 4 Press the Reset/Information button for 1 s.
 - ▷ The display indicates step [01].
 - ▷ The PFUs start the burner pre-purge procedure.

WARNING

The pre-purge duration is not included in the program. Pre-purge until the combustion chamber has been adequately ventilated.

- 5 Press the Reset/Information button for 1 s.
 - ▷ The display indicates step [02].
 - ▷ The PFUs start the pilot burners.
- 6 Press the Reset/Information button for 1 s.
 - ▷ The display indicates step [03].
 - ▷ The PFUs start the main burners, the pilot burners remain switched on.
- 7 Press the Reset/Information button for 1 s.
 - ▷ The display indicates step [04].
 - ▷ The PFUs 780..L activate the external air valves, the main burners switch to high-fire rate.
- 8 Press the Reset/Information button for 1 s.
 - ▷ The display indicates step [03].
 - ▷ The PFUs 780..L deactivate the external air valves, the main burners switch to low-fire rate.
 - ▷ Each time the Reset/Information button is pressed, the air valves are opened (the burners switch to high-fire rate, the display indicates [04]) or closed (the burners switch to low-fire rate, the display indicates [03]).

Faults

DANGER

Electric shocks can be fatal! Before working on possible live components, ensure the unit is disconnected from the power supply.
Fault-clearance must only be undertaken by authorized, trained personnel.

- ▷ Faults may be cleared only using the measures described below.
- ▷ If the PFA does not respond even though all faults have been remedied: remove the unit and return it to the manufacturer for inspection.

- ? **Faults**
- ! **Cause**
- **Remedy**

? **The 7-segment display does not light up.**

- ! Mains voltage is not applied.
- Check the wiring, apply mains voltage (see type label).

? **The display blinks and indicates [Pb]**

or

? **A bus fault is indicated on the automation system.**

- ! The PROFIBUS DP data traffic has suffered a fault.
- ! Bus cable interrupted.

- Check bus cable.
 - ! Bus cable connections confused in the plug.
 - Check the wiring.
 - ! A and B cables confused.
 - Check cables.
 - ! Terminal resistors connected incorrectly.
 - Switch on the terminal resistors on the first and last station in the segment and switch them off for all other stations.
 - ! Incorrect PROFIBUS address set.
 - Correct the address setting – switch the unit off and then on again to save the address.
 - ! Bus cables too long.
 - Reduce cable length or baud rate – see page 5 (Commissioning).
- ▷ If the transfer rate is reduced, remember that this will increase the signal running times to and from the individual units.
- ! Poor shielding.
 - The shield must be connected to the shield clips in the PROFIBUS DP plugs in full and over a wide area.
 - ! Poor equipotential bond.
 - The PROFIBUS DP shield should be connected at all points to the same ground potential by grounding the BGT. If necessary an equipotential bond cable must be laid.
 - ! If faults only occur sporadically in the PROFIBUS DP system, and are mostly only indicated briefly in the bus master, the terminal resistors, shielding, cable lengths/routes, equipotential bond and the use of interference-suppressed ignition electrode plugs (1 k Ω) in particular should be checked.
- ▷ Further notes on building PROFIBUS DP networks are set out in the instructions for the automation system or, for example, in the “Installation Guideline for PROFIBUS DP/FMS”, available from the PUO (PROFIBUS User Organization).

? **All the burners are constantly in operation, regardless of data traffic.**

- ! The PFA is set to manual mode.
- Switch the PFA to “normal operation”.

? **The display indicates bE.**

- ! Profibus module fault.
- Remove the unit and return it to the manufacturer.

? **The display indicates 30, 31, 34, 80, 89, 94, 95, 96, 97, 98 or 99.**

- ! Internal faults.
- Remove the unit and return it to the manufacturer.

Technical data

BGT

Weight: 2.3 kg.

PFA

Front width 8 depth units = 40.6 mm.

Overall height 3 height units = 128.4 mm.

Ambient temperature: -20°C to +60°C.

4 digital inputs: 24 V DC, \pm 10%, < 10 mA.

4 digital outputs for controlling small relays 24 V, max. 250 mW (10 mA).

Mains voltage:

220/240 V AC, -15/+10%, 50/60 Hz,
110/120 V AC, -15/+10%, 50/60 Hz,
for grounded and ungrounded mains.

Power consumption: < 25 VA.

Permitted operating altitude: < 2000 m AMSL.

Weight: approx. 0.75 kg.

Designed lifetime

This information on the designed lifetime is based on using the product in accordance with these operating instructions. Once the designed lifetime has been reached, safety-relevant products must be replaced. Designed lifetime (based on date of manufacture) in accordance with EN 230 and EN 298 for PFA/BGT: 10 years.

You can find further explanations in the applicable rules and regulations and on the afecor website (www.afecor.org).

This procedure applies to heating systems. For thermo-processing equipment, observe local regulations.

Logistics

Transport

Protect the unit from external forces (blows, shocks, vibration). On receipt of the product, check that the delivery is complete, see page 2 (Part designations). Report any transport damage immediately.

Storage

Store the product in a dry and clean place.

Storage temperature: see page 7 (Technical data).

Storage time: 6 months in the original packaging before using for the first time. If stored for longer than this, the overall service life will be reduced by the corresponding amount of extra storage time.

Disposal

Devices with electronic components:

WEEE Directive 2012/19/EU – Waste Electrical and Electronic Equipment Directive



At the end of the product life (number of operating cycles reached), dispose of the packaging and product in a corresponding recycling centre. Do not dispose of the unit with the usual domestic refuse. Do not burn the product. On request, old units may be returned carriage paid to the manufacturer in accordance with the relevant waste legislation requirements.

BGT SA-9U/1DP700 (8 440 229 1)

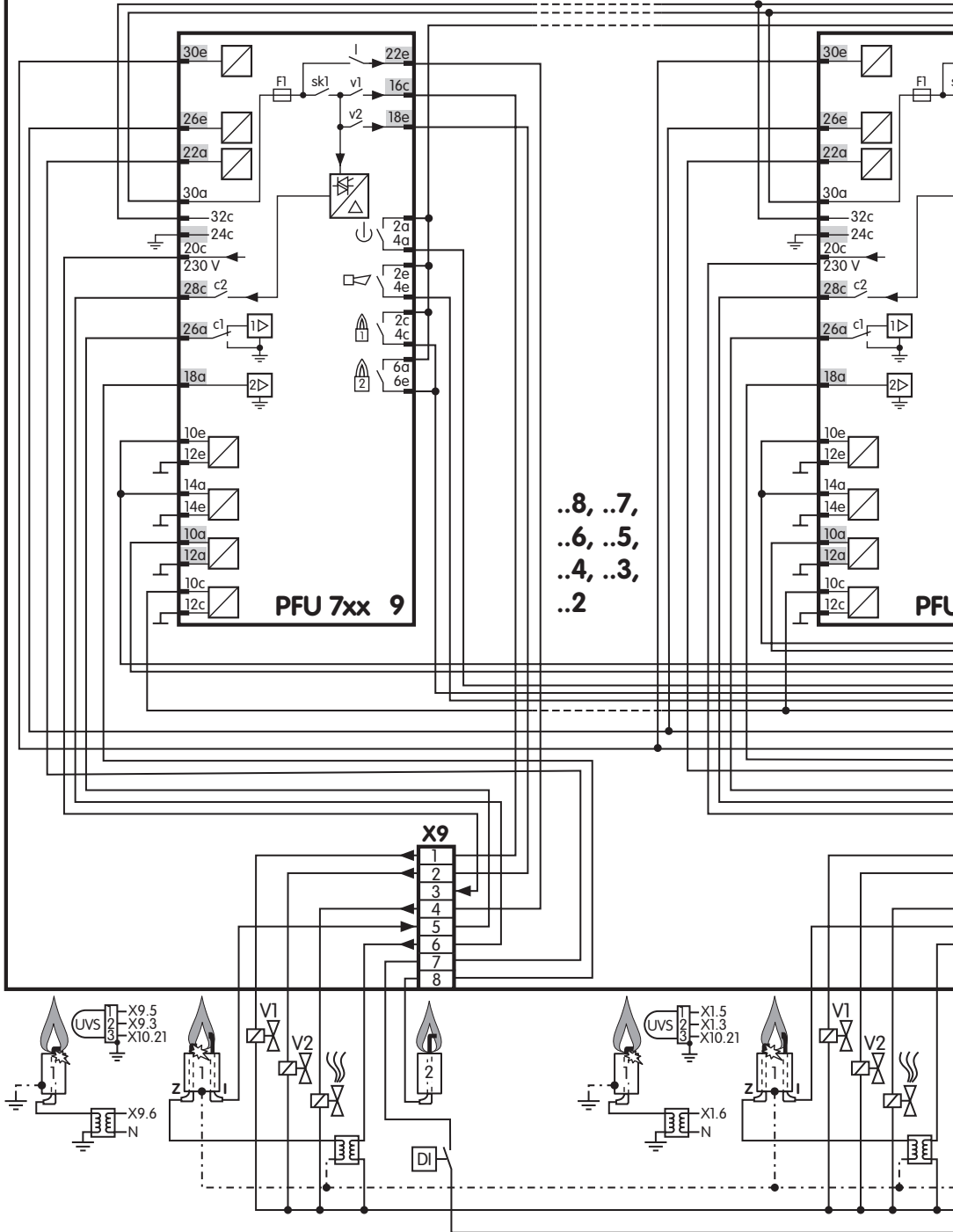

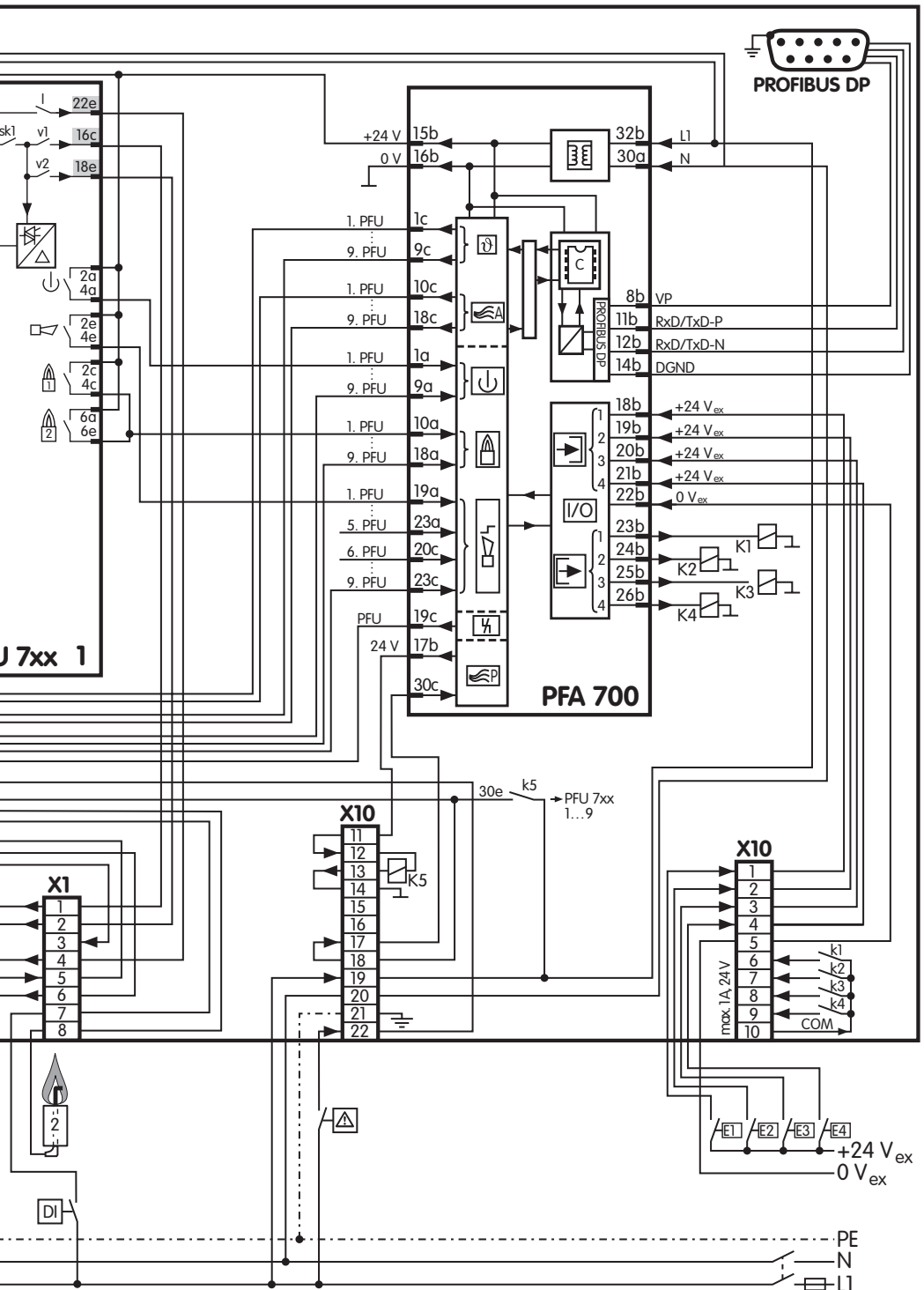

BGT SA-8U/1DP710 (84402292)

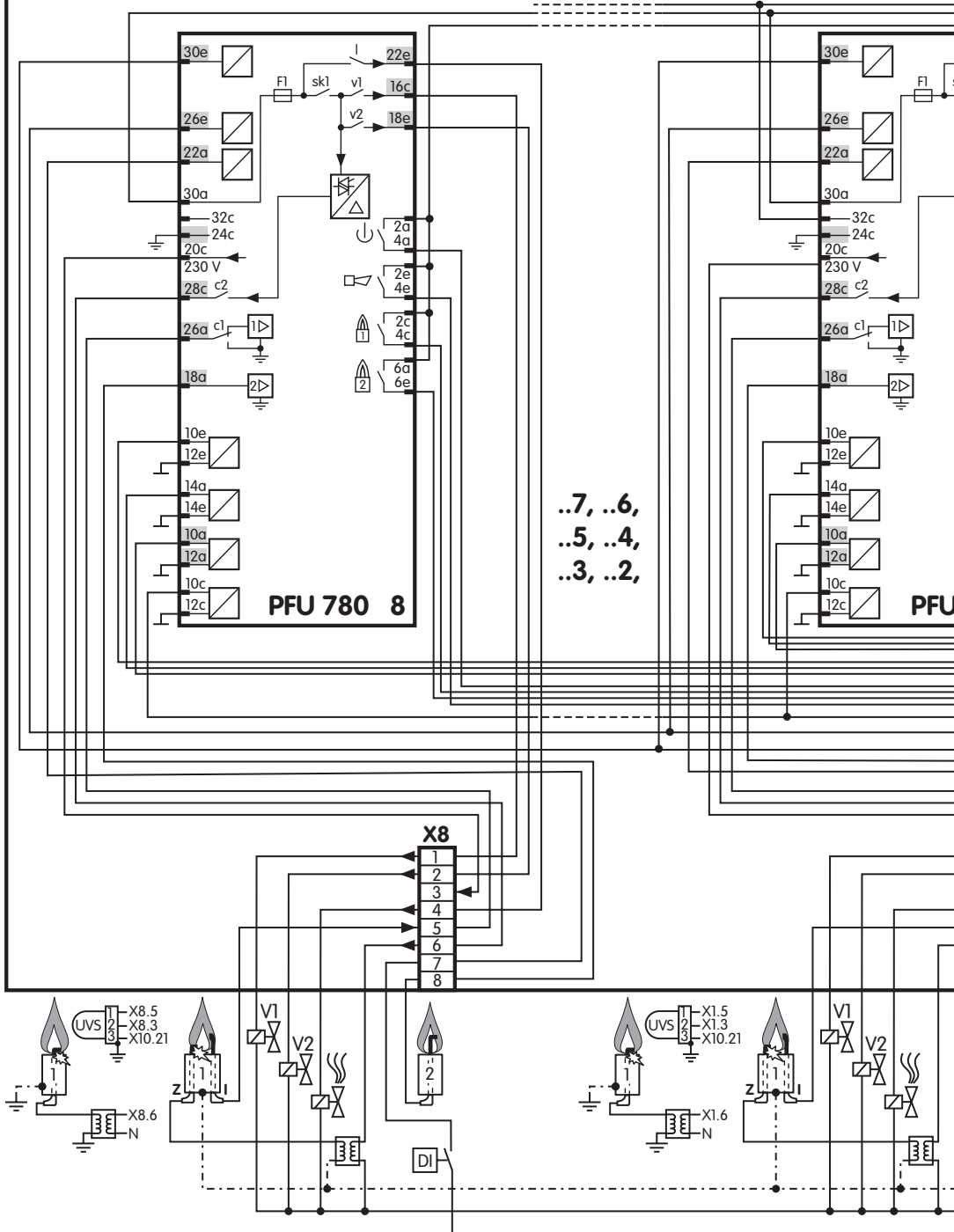

Accessories

“Changed parameters” stickers

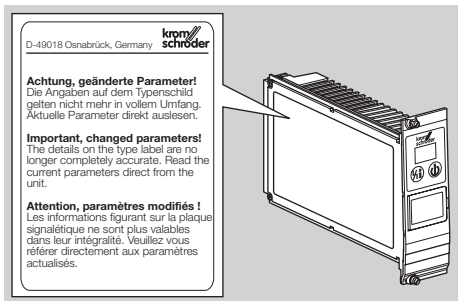

Affix on the PFA if parameters set at the factory have been changed.

100 pcs, Order No.: 74921492.

Opto-adaptor PCO 200 including BCSofT CD-ROM

Order No.: 74960625.

Bluetooth adapter PCO 300 including BCSofT CD-ROM

Order No.: 74960617.

▷ Downloading the BCSofT software, see www.docuthek.com

Profibus plug for PFA

For connecting Profibus stations to the Profibus bus cable. To replace existing PROFIBUS plug connectors if a new PFA 700 is operated in an old module subrack with the Order No. 84402283 in order to improve EMC – see page 4 (Replacing the PFA).

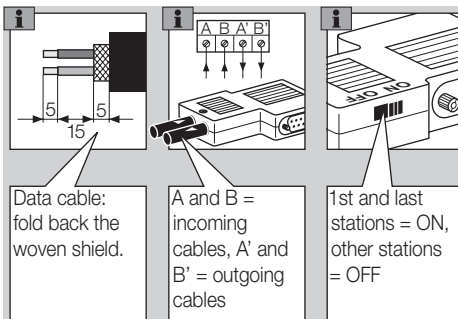

Data cable:
fold back the
woven shield.

A and B =
incoming
cables, A' and
B' = outgoing
cables

1st and last
stations = ON,
other stations
= OFF

- ▷ Data cables A and B must not be reversed (A' is connected to A, B' is connected to B).
- ▷ The power supply for the bus terminator is provided by the PFA. The bus terminator can be connected in the PROFIBUS plug. If the switch is set to ON, outputs A' and B' are switched off.
- ▷ To ensure optimum cable clamping, insert one of the fillers supplied into the housing depending on the thickness of the cables.

Scope of delivery: Profibus plug with shielding capacitor, fillers for cable clamping,

Order No.: 74960621.

Certification

Declaration of conformity



We, the manufacturer, hereby declare that the products BGT and PFA comply with the essential requirements of the following Directives and Standards.

Directives:

- 2006/95/EC,
- 2004/108/EC,
- designed for applications pursuant to Directive 98/37/EC.

Standards:

- EN 50170-2,
- EN 60730.

The production is subject to a Quality Management System pursuant to DIN EN ISO 9001.

Elster GmbH

Scan of the Declaration of conformity (D, GB) – see www.docuthek.com

Eurasian Customs Union



The product BGT meets the technical specifications of the Eurasian Customs Union.

Contact

If you have any technical questions, please contact your local branch office/agent. The addresses are available on the Internet or from Elster GmbH.

We reserve the right to make technical modifications in the interests of progress.

Honeywell

**krom
schroder**

Elster GmbH
Strothweg 1, D-49504 Lotte (Büren)
Tel. +49 541 1214-0

Fax +49 541 1214-370

hts.lotte@honeywell.com, www.kromschroeder.com